

North Star Water Treatment Systems PROFESSIONAL ADVANTAGE COMMERCIAL SERIES WATER SOFTENERS – 1" VALVE

All models have 1" inlet and outlet connection. For 1-1/2" connection, order Adaptor Kit 7129211.

PA071S - 200#

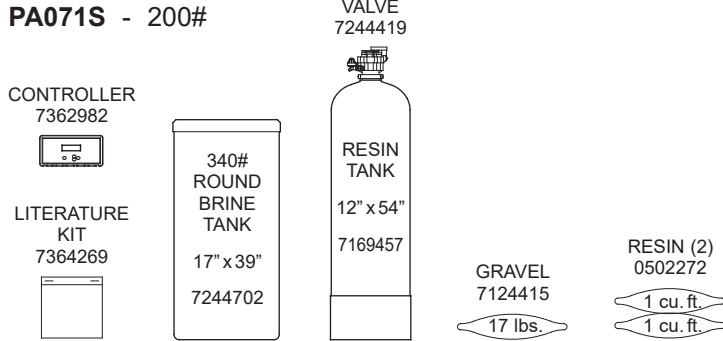

PA071D - 390#

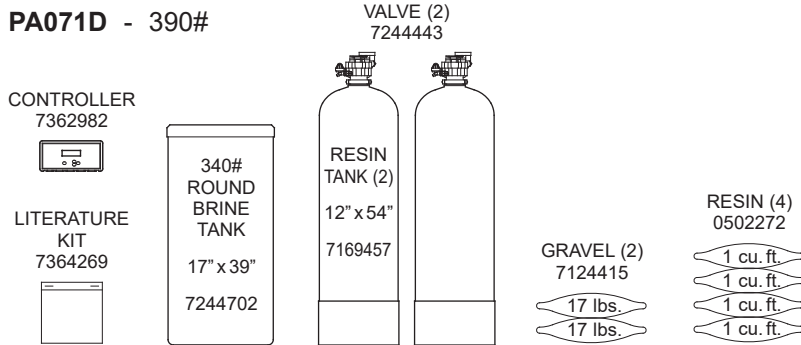

PA071T - 600#

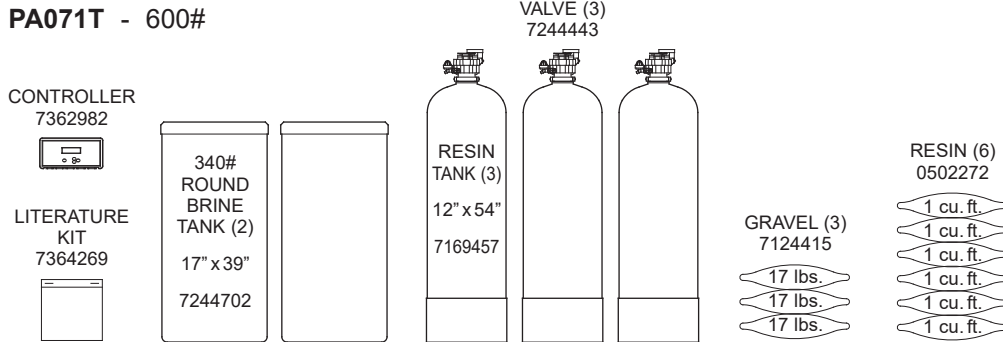



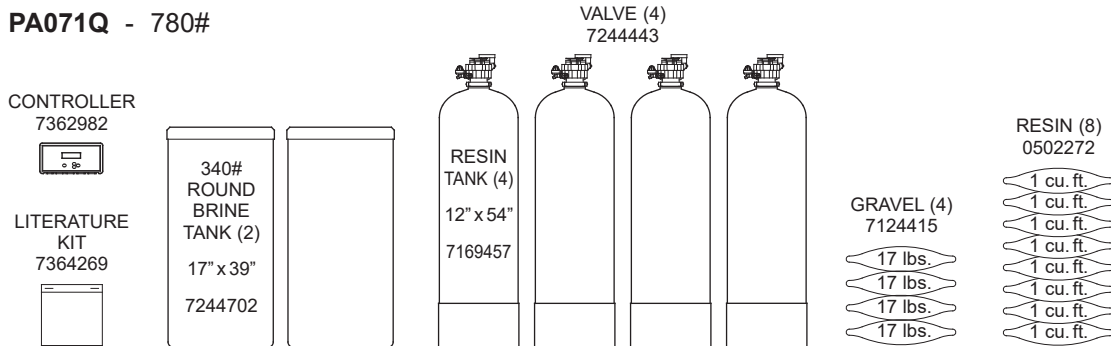







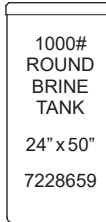
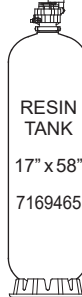

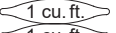
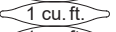
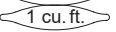



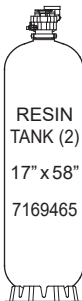
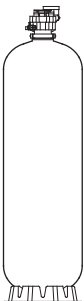

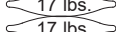
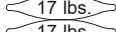
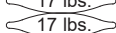
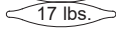
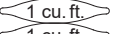
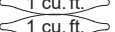
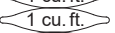
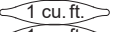
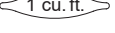

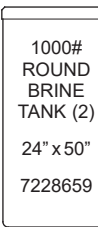

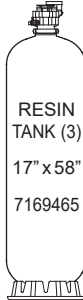
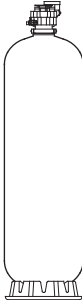

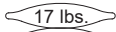
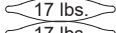
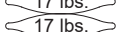
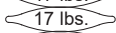
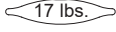
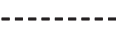
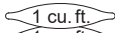
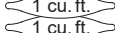
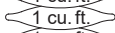
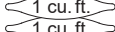
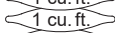
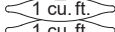
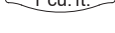



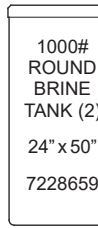

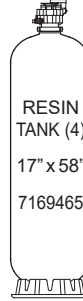
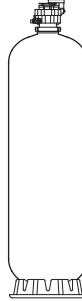
PA071Q - 780#



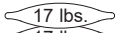
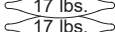
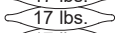
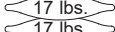
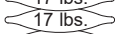
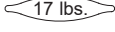
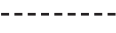

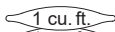
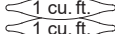
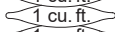
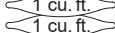
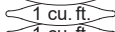
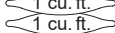
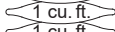
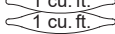









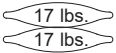
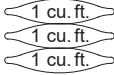

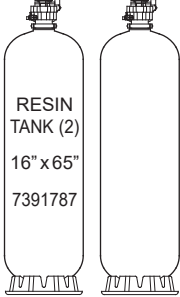
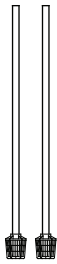

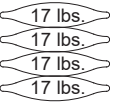
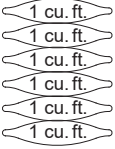
North Star Water Treatment Systems PROFESSIONAL ADVANTAGE COMMERCIAL SERIES WATER SOFTENERS – 1" VALVE

All models have 1" inlet and outlet connection. For 1-1/2" connection, order Adaptor Kit 7129211.

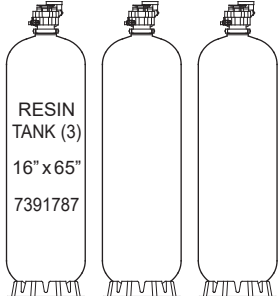
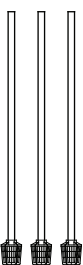
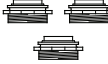
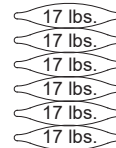
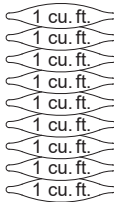
<p>PA101S - 300# PA131S - 360#</p> <p>CONTROLLER 7362982</p>  <p>LITERATURE KIT 7364269</p> 	<p>1000# ROUND BRINE TANK 24" x 50" 7228659</p> 	<p>VALVE 7244427</p> <p>RESIN TANK 17" x 58" 7169465</p> 	<p>GRAVEL (2) 7124415</p>  	<p>RESIN 0502272 101 - (3) 131 - (4)</p>   	
<p>PA101D - 590# PA131D - 690#</p> <p>CONTROLLER 7362982</p>  <p>LITERATURE KIT 7364269</p> 	<p>1000# ROUND BRINE TANK 24" x 50" 7228659</p> 	<p>VALVE (2) 7244451</p> <p>RESIN TANK (2) 17" x 58" 7169465</p>  	<p>BRINE LINE KIT 7244744</p> 	<p>GRAVEL (4) 7124415</p>    	<p>RESIN 0502272 101 - (6) 131 - (8)</p>     
<p>PA101T - 900# PA131T - 1050#</p> <p>CONTROLLER 7362982</p>  <p>LITERATURE KIT 7364269</p> 	<p>1000# ROUND BRINE TANK (2) 24" x 50" 7228659</p>  	<p>VALVE (3) 7244451</p> <p>RESIN TANK (3) 17" x 58" 7169465</p>   	<p>BRINE LINE KIT 7244744</p> 	<p>GRAVEL (6) 7124415</p>      	<p>RESIN 0502272 101 - (9) 131 - (12)</p>        
<p>PA101Q - 1180# PA131Q - 1390#</p> <p>CONTROLLER 7362982</p>  <p>LITERATURE KIT 7364269</p> 	<p>1000# ROUND BRINE TANK (2) 24" x 50" 7228659</p>  	<p>VALVE (4) 7244451</p> <p>RESIN TANK (4) 17" x 58" 7169465</p>    	<p>BRINE LINE KIT (2) 7244744</p>  	<p>GRAVEL (8) 7124415</p>        	<p>RESIN 0502272 101 - (12) 131 - (16)</p>          



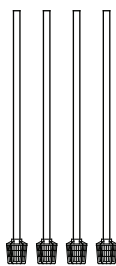
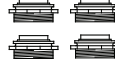
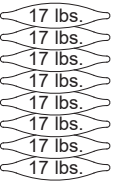
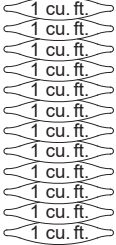

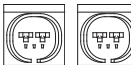







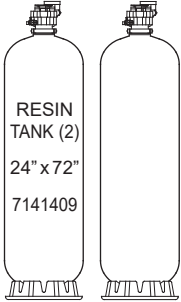

North Star Water Treatment Systems PROFESSIONAL ADVANTAGE COMMERCIAL SERIES WATER SOFTENERS – 1" VALVE

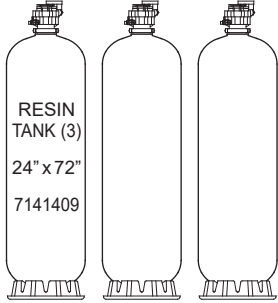
All models have 1" inlet and outlet connection. For 1-1/2" connection, order Adaptor Kit 7129211.

PA101S-1 - 300# PA131S-1 - 360#	VALVE 7244427  RESIN TANK 16" x 65" 7391787	DISTRIBUTOR ASM. 7127895 	NECK ADAPTER KIT 7395642 	RESIN 0502272 101 - (3) 131 - (4)	GRAVEL (2) 7124415 	
CONTROLLER 7362982  LITERATURE KIT 7364269 	1000# ROUND BRINE TANK 24" x 50" 7228659					
PA101D-1 - 590# PA131D-1 - 690#	VALVE (2) 7244451  RESIN TANK (2) 16" x 65" 7391787	DISTRIBUTOR ASM. (2) 7127895 	NECK ADAPTER KIT (2) 7395642 	RESIN 0502272 101 - (6) 131 - (8)	GRAVEL (4) 7124415 	
CONTROLLER 7362982  LITERATURE KIT 7364269 	1000# ROUND BRINE TANK 24" x 50" 7228659		BRINE LINE KIT 7244744 			
PA101T-1 - 900# PA131T-1 - 1050#	VALVE (3) 7244451  RESIN TANK (3) 16" x 65" 7391787	DISTRIBUTOR ASM. (3) 7127895 	NECK ADAPTER KIT (3) 7395642 	RESIN 0502272 101 - (9) 131 - (12)	GRAVEL (6) 7124415 	
CONTROLLER 7362982  LITERATURE KIT 7364269 	1000# ROUND BRINE TANK (2) 24" x 50" 7228659		BRINE LINE KIT 7244744 			
PA101Q-1 - 1180# PA131Q-1 - 1390#	VALVE (4) 7244451  RESIN TANK (4) 16" x 65" 7391787	DISTRIBUTOR ASM. (4) 7127895 	NECK ADAPTER KIT (4) 7395642 	RESIN 0502272 101 - (12) 131 - (16)	GRAVEL (8) 7124415 	
CONTROLLER 7362982  LITERATURE KIT 7364269 	1000# ROUND BRINE TANK (2) 24" x 50" 7228659		BRINE LINE KIT (2) 7244744 			

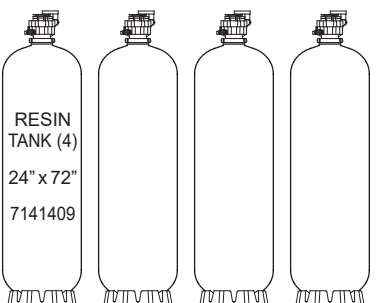











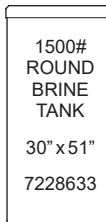
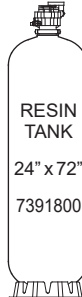





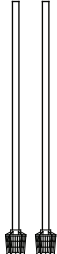

North Star Water Treatment Systems PROFESSIONAL ADVANTAGE COMMERCIAL SERIES WATER SOFTENERS – 1" VALVE

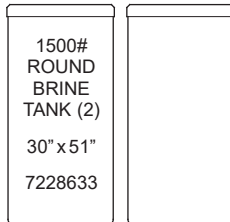
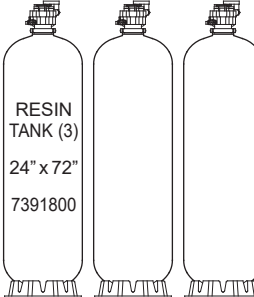
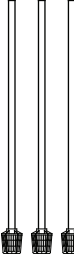
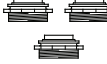
All models have 1" inlet and outlet connection. For 1-1/2" connection, order Adaptor Kit 7129211.

PA191S - 620# PA251S - 720# PA321S - 820#		VALVE 7244427 	RESIN 0502272 191 - (6) 251 - (8) 321 - (10)
CONTROLLER 7362982 	1500# ROUND BRINE TANK 30" x 51" 7228633	RESIN TANK 24" x 72" 7141409	GRAVEL (3) 7124423 (1) 50 lbs. 7127073 (1) 50 lbs. 4104600 (1) 50 lbs.
LITERATURE KIT 7364269 			1 cu. ft. 1 cu. ft. 1 cu. ft. 1 cu. ft. 1 cu. ft.
PA191D - 1290# PA251D - 1500# PA321D - 1700#		VALVE (2) 7244451 	GRAVEL (6) 7124423 (2) 50 lbs. 50 lbs. 7127073 (2) 50 lbs. 50 lbs. 4104600 (2) 50 lbs. 50 lbs.
CONTROLLER 7362982 	1500# ROUND BRINE TANK 30" x 51" 7228633	RESIN TANK (2) 24" x 72" 7141409	BRINE LINE KIT 7244744 
LITERATURE KIT 7364269 			RESIN 0502272 191 - (12) 251 - (16) 321 - (20)
			1 cu. ft. 1 cu. ft. 1 cu. ft. 1 cu. ft. 1 cu. ft. 1 cu. ft. 1 cu. ft. 1 cu. ft. 1 cu. ft. 1 cu. ft.
PA191T - 1910# PA251T - 2220# PA321T - 2530#		VALVE (3) 7244451 	GRAVEL (9) 7124423 (3) 50 lbs. 50 lbs. 50 lbs. 7127073 (3) 50 lbs. 50 lbs. 50 lbs. 4104600 (3) 50 lbs. 50 lbs. 50 lbs.
CONTROLLER 7362982 	1500# ROUND BRINE TANK (2) 30" x 51" 7228633	RESIN TANK (3) 24" x 72" 7141409	BRINE LINE KIT 7244744 
LITERATURE KIT 7364269 			RESIN 0502272 191 - (18) 251 - (24) 321 - (30)
			1 cu. ft. 1 cu. ft. 1 cu. ft. 1 cu. ft. 1 cu. ft. 1 cu. ft. 1 cu. ft. 1 cu. ft. 1 cu. ft. 1 cu. ft. 1 cu. ft. 1 cu. ft.
PA191Q - 2580# PA251Q - 2990# PA321Q - 3410#		VALVE (4) 7244451 	GRAVEL (12) 7124423 (4) 50 lbs. 50 lbs. 50 lbs. 50 lbs. 7127073 (4) 50 lbs. 50 lbs. 50 lbs. 50 lbs. 4104600 (4) 50 lbs. 50 lbs. 50 lbs.
CONTROLLER 7362982 	1500# ROUND BRINE TANK (2) 30" x 51" 7228633	RESIN TANK (4) 24" x 72" 7141409	BRINE LINE KIT (2) 7244744  
LITERATURE KIT 7364269 			RESIN 0502272 191 - (24) 251 - (32) 321 - (40)
			1 cu. ft. 1 cu. ft. 1 cu. ft. 1 cu. ft. 1 cu. ft. 1 cu. ft. 1 cu. ft. 1 cu. ft. 1 cu. ft. 1 cu. ft. 1 cu. ft. 1 cu. ft. 1 cu. ft. 1 cu. ft.

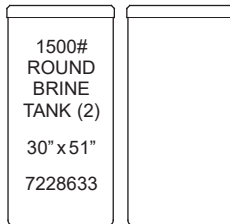
North Star Water Treatment Systems **PROFESSIONAL ADVANTAGE** COMMERCIAL SERIES WATER SOFTENERS – 1" VALVE

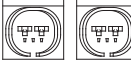
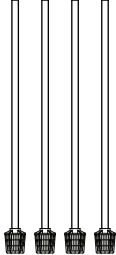
All models have 1" inlet and outlet connection. For 1-1/2" connection, order Adaptor Kit 7129211.

<p>PA191S-1 - 620# PA251S-1 - 720# PA321S-1 - 820#</p> <p>CONTROLLER 7362982</p>  <p>LITERATURE KIT 7364269</p> 	<p>1500# ROUND BRINE TANK 30" x 51" 7228633</p> 	<p>VALVE 7244427</p> <p>RESIN TANK 24" x 72" 7391800</p> 	<p>DISTRIBUTOR ASM. 7127895</p> 	<p>NECK ADAPTER KIT 7395642</p> 	<p>RESIN 0502272</p> <p>GRAVEL (3) 7124423 (1) 50 lbs.</p> <p>7127073 (1) 50 lbs.</p> <p>4104600 (1) 50 lbs.</p>	<p>191 - (6) 251 - (8) 321 - (10)</p> <p>1 cu. ft. 1 cu. ft. 1 cu. ft. 1 cu. ft. 1 cu. ft.</p>
<p>PA191D-1 - 1290# PA251D-1 - 1500# PA321D-1 - 1700#</p> <p>CONTROLLER 7362982</p>  <p>LITERATURE KIT 7364269</p> 	<p>1500# ROUND BRINE TANK 30" x 51" 7228633</p> 	<p>VALVE (2) 7244451</p> <p>RESIN TANK (2) 24" x 72" 7391800</p> 	<p>DISTRIBUTOR ASM. (2) 7127895</p> 	<p>NECK ADAPTER KIT (2) 7395642</p>  <p>BRINE LINE KIT 7244744</p> 	<p>GRAVEL (6) 7124423 (2) 50 lbs. 50 lbs.</p> <p>7127073 (2) 50 lbs. 50 lbs.</p> <p>4104600 (2) 50 lbs. 50 lbs.</p>	<p>RESIN 0502272</p> <p>191 - (12) 251 - (16) 321 - (20)</p> <p>1 cu. ft. 1 cu. ft. 1 cu. ft. 1 cu. ft. 1 cu. ft. 1 cu. ft. 1 cu. ft. 1 cu. ft. 1 cu. ft. 1 cu. ft.</p>
<p>PA191T-1 - 1910# PA251T-1 - 2220# PA321T-1 - 2530#</p> <p>CONTROLLER 7362982</p>  <p>LITERATURE KIT 7364269</p> 	<p>1500# ROUND BRINE TANK (2) 30" x 51" 7228633</p> 	<p>VALVE (3) 7244451</p> <p>RESIN TANK (3) 24" x 72" 7391800</p> 	<p>DISTRIBUTOR ASM. (3) 7127895</p> 	<p>NECK ADAPTER KIT (3) 7395642</p>  <p>BRINE LINE KIT 7244744</p> 	<p>GRAVEL (9) 7124423 (3) 50 lbs. 50 lbs. 50 lbs.</p> <p>7127073 (3) 50 lbs. 50 lbs. 50 lbs.</p> <p>4104600 (3) 50 lbs. 50 lbs. 50 lbs.</p>	<p>RESIN 0502272</p> <p>191 - (18) 251 - (24) 321 - (30)</p> <p>1 cu. ft. 1 cu. ft. 1 cu. ft. 1 cu. ft. 1 cu. ft. 1 cu. ft. 1 cu. ft. 1 cu. ft. 1 cu. ft. 1 cu. ft. 1 cu. ft. 1 cu. ft.</p>
<p>PA191Q-1 - 2580# PA251Q-1 - 2990# PA321Q-1 - 3410#</p> <p>CONTROLLER 7362982</p>  <p>LITERATURE KIT 7364269</p> 	<p>1500# ROUND BRINE TANK (2) 30" x 51" 7228633</p> 	<p>VALVE (4) 7244451</p> <p>RESIN TANK (4) 24" x 72" 7391800</p> 	<p>BRINE LINE KIT (2) 7244744</p>  <p>DISTRIBUTOR ASM. (4) 7127895</p> 	<p>NECK ADAPTER KIT (4) 7395642</p> 	<p>GRAVEL (12) 7124423 (4) 50 lbs. 50 lbs. 50 lbs. 50 lbs.</p> <p>7127073 (4) 50 lbs. 50 lbs. 50 lbs. 50 lbs.</p> <p>4104600 (4) 50 lbs. 50 lbs. 50 lbs. 50 lbs.</p>	<p>RESIN 0502272</p> <p>191 - (24) 251 - (32) 321 - (40)</p> <p>1 cu. ft. 1 cu. ft. 1 cu. ft. 1 cu. ft. 1 cu. ft. 1 cu. ft. 1 cu. ft. 1 cu. ft. 1 cu. ft. 1 cu. ft. 1 cu. ft. 1 cu. ft. 1 cu. ft. 1 cu. ft.</p>

North Star Water Treatment Systems **PROFESSIONAL ADVANTAGE** **COMMERCIAL SERIES WATER FILTERS – 1" VALVE**

All models have 1" inlet and outlet connection. For 1-1/2" connection, order Adaptor Kit 7129211.

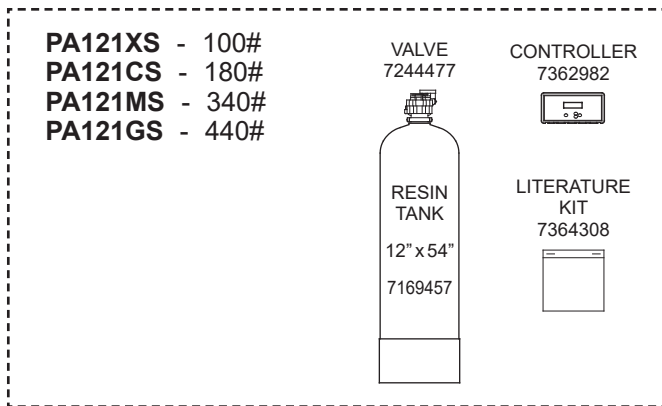

Mineral Bed	MODEL	GRAVEL 7124415		FILTER SAND 0993080		ACTIVATED CARBON 7336834	GREENSAND PLUS™ 7331101	ANTHRACITE 0993070		GARNET 0993090	
		lbs.	bags	lbs.	bags	1 cu. ft. bags	1/2 cu. ft. bags	lbs.	bags	lbs.	bags
	PA121XS	34	2	–	–	–	–	–	–	–	–
	PA121CS	17	1	–	–	2	–	–	–	–	–
	PA121MS	34	2	50	1	–	–	52	1	25*	1*
	PA121GS	17	1	–	–	–	3	52	1	25*	1*

Greensand Plus™ is a trademark of Inversand Company.

*1/2 of the bag included is used.

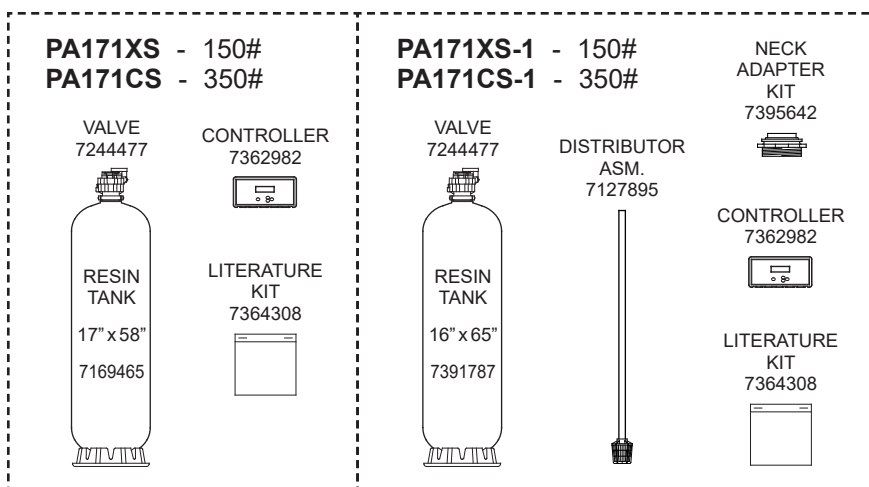

Mineral Bed	MODEL	GRAVEL 7124423		ACTIVATED CARBON 7336834
		lbs.	bags	1 cu. ft. bags
	PA171XS, PA171XS-1	100	2	–
	PA171CS, PA171CS-1	100	2	4

North Star Water Treatment Systems PROFESSIONAL ADVANTAGE COMMERCIAL SERIES WATER FILTERS – 1" VALVE

All models have 1" inlet and outlet connection. For 1-1/2" connection, order Adaptor Kit 7129211.

PA121XD - 190#
PA121CD - 370#
PA121MD - 620#
PA121GD - 830#

VALVE (2)
7244485

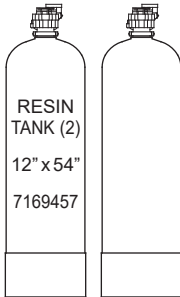

RESIN TANK (2)
12" x 54"
7169457

CONTROLLER
7362982



LITERATURE KIT
7364308



Mineral Bed	MODEL	GRAVEL 7124415		FILTER SAND 0993080		ACTIVATED CARBON 7336834	GREENSAND PLUS™ 7331101	ANTHRACITE 0993070		GARNET 0993090	
		lbs.	bags	lbs.	bags	1 cu. ft. bags	1/2 cu. ft. bags	lbs.	bags	lbs.	bags
	PA121XD	68	4	–	–	–	–	–	–	–	–
	PA121CD	34	2	–	–	4	–	–	–	–	–
	PA121MD	68	4	100	2	–	–	104	2	50	1
	PA121GD	34	2	–	–	–	6	52	1	50	1

Greensand Plus™ is a trademark of Inversand Company.

PA171XD - 300#
PA171CD - 700#

VALVE (2)
7244485

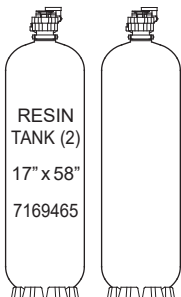

RESIN TANK (2)
17" x 58"
7169465

CONTROLLER
7362982



LITERATURE KIT
7364308



PA171XD-1 - 300#
PA171CD-1 - 700#

VALVE (2)
7244485

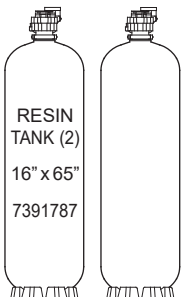

RESIN TANK (2)
16" x 65"
7391787

DISTRIBUTOR
ASM. (2)
7127895

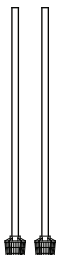

NECK ADAPTER
KIT (2)
7395642

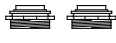

CONTROLLER
7362982



LITERATURE KIT
7364308



Mineral Bed	MODEL	GRAVEL 7124423		ACTIVATED CARBON 7336834
		lbs.	bags	1 cu. ft. bags
	PA171XD, PA171XD-1	200	4	–
	PA171CD, PA171CD-1	200	4	8

7

North Star Water Treatment Systems **PROFESSIONAL ADVANTAGE** **COMMERCIAL SERIES WATER FILTERS – 1" VALVE**

All models have 1" inlet and outlet connection. For 1-1/2" connection, order Adaptor Kit 7129211.

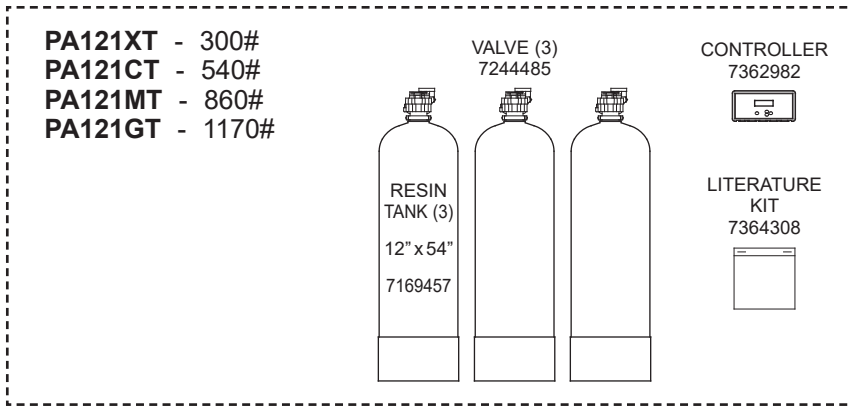

Mineral Bed	MODEL	GRAVEL 7124415		FILTER SAND 0993080		ACTIVATED CARBON 7336834	GREENSAND PLUS™ 7331101	ANTHRACITE 0993070		GARNET 0993090	
		lbs.	bags	lbs.	bags	1 cu. ft. bags	1/2 cu. ft. bags	lbs.	bags	lbs.	bags
	PA121XT	102	6	–	–	–	–	–	–	–	–
	PA121CT	51	3	–	–	6	–	–	–	–	–
	PA121MT	102	6	150	3	–	–	156	3	75*	2*
	PA121GT	51	3	–	–	–	9	104*	2*	75*	2*

Greensand Plus™ is a trademark of Inversand Company.

*1-1/2 of the bags included are used.

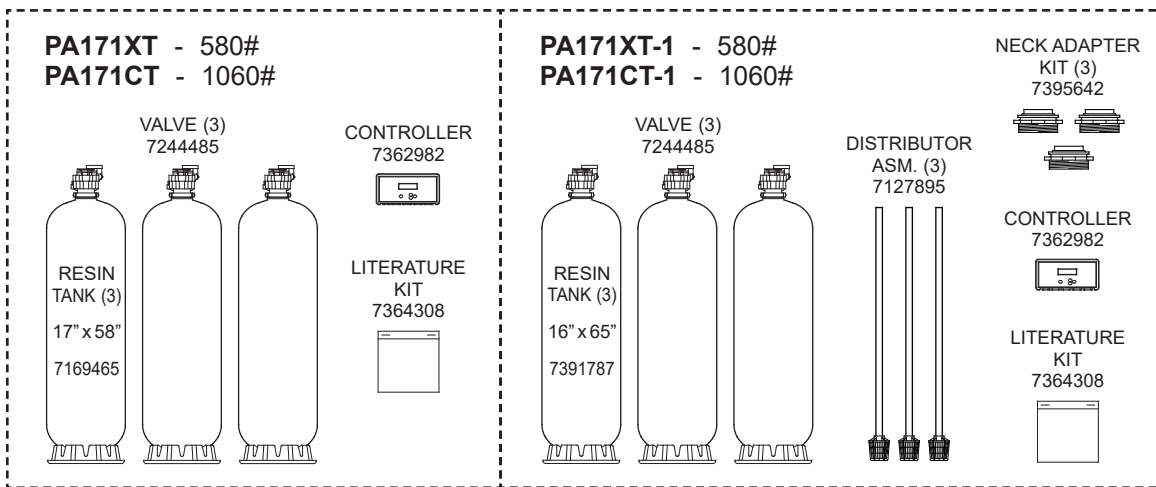

Mineral Bed	MODEL	GRAVEL 7124423		ACTIVATED CARBON 7336834
		lbs.	bags	1 cu. ft. bags
	PA171XT, PA171XT-1	300	6	–
	PA171CT, PA171CT-1	300	6	12

North Star Water Treatment Systems **PROFESSIONAL ADVANTAGE** **COMMERCIAL SERIES WATER FILTERS – 1" VALVE**

All models have 1" inlet and outlet connection. For 1-1/2" connection, order Adaptor Kit 7129211.

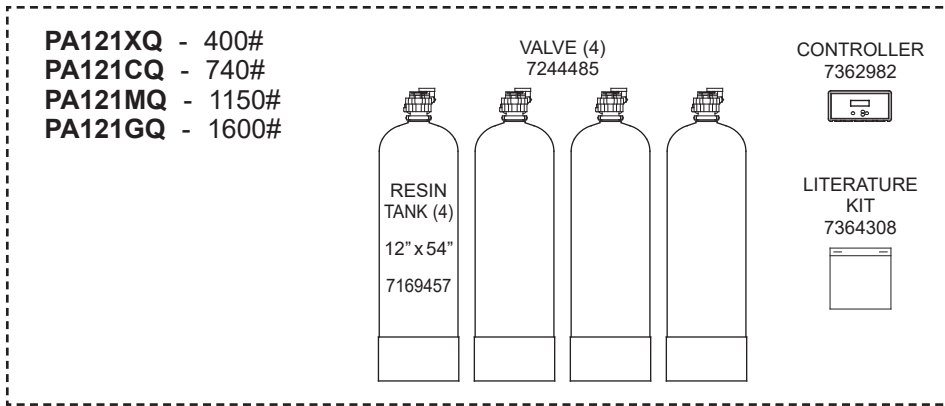

Mineral Bed	MODEL	GRAVEL 7124415		FILTER SAND 0993080		ACTIVATED CARBON 7336834	GREENSAND PLUS™ 7331101	ANTHRACITE 0993070		GARNET 0993090	
		lbs.	bags	lbs.	bags	1 cu. ft. bags	1/2 cu. ft. bags	lbs.	bags	lbs.	bags
	PA121XQ	136	8	–	–	–	–	–	–	–	–
	PA121CQ	68	4	–	–	8	–	–	–	–	–
	PA121MQ	136	8	200	4	–	–	208	4	100	2
	PA121GQ	68	4	–	–	–	12	104	2	100	2

Greensand Plus™ is a trademark of Inversand Company.

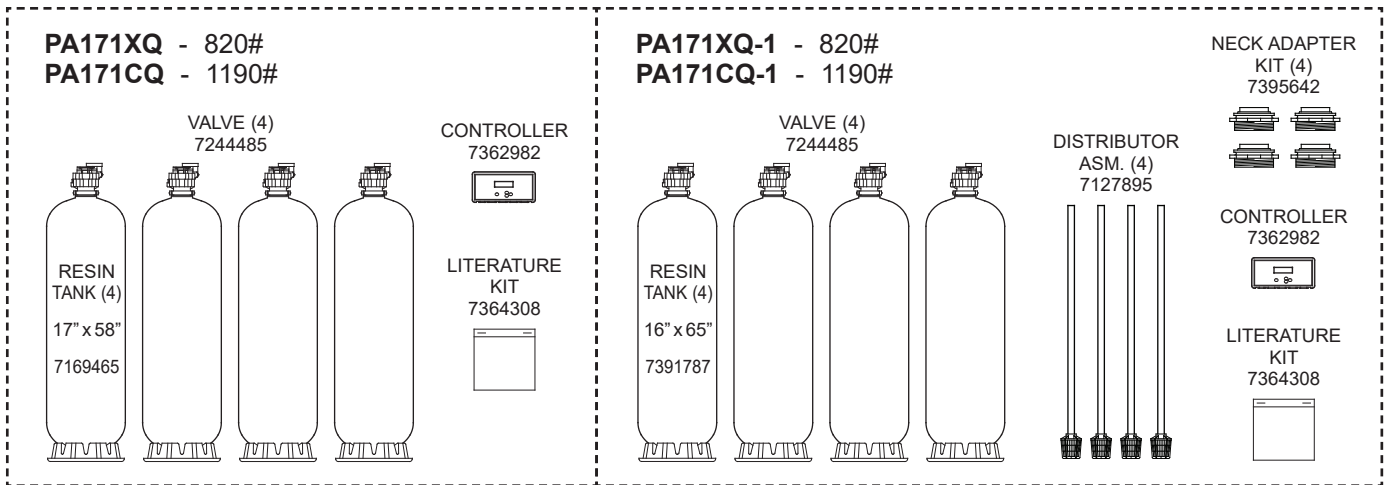

Mineral Bed	MODEL	GRAVEL 7124423		ACTIVATED CARBON 7336834
		lbs.	bags	1 cu. ft. bags
	PA171XQ, PA171XQ-1	400	8	–
	PA171CQ, PA171CQ-1	400	8	16

North Star Water Treatment Systems PROFESSIONAL ADVANTAGE COMMERCIAL SERIES WATER FILTERS – 1” VALVE

BEDDING SEQUENCE OF GRAVEL & MINERALS

NOTE: Be sure distributor assembly is centered in tank before filling.

**NO MEDIA
(GRAVEL ONLY) FILTERS**

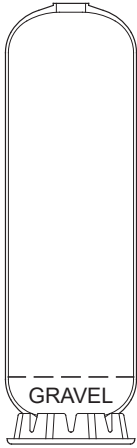

CARBON FILTERS

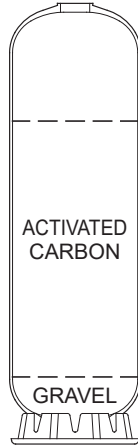

MULTI-MEDIA FILTERS

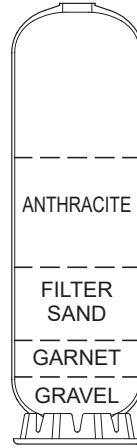

**GREENSAND PLUS™
FILTERS**



North Star Water Treatment Systems PROFESSIONAL ADVANTAGE COMMERCIAL SERIES – 1” VALVE

Media		
	Part Number	Weight (lbs.)
Resin	0502272	53
Gravel, Quartz	7124415	17
	7124423	50
Gravel, Medium	7127073	50
Anthracite	0993070	52
Garnet	0993090	50
Sand, Filter	0993080	50
Carbon, Activated	7336834	27.5
Greensand Plus™	7331101	44

Accessory	
	Part Number
Adaptors (2) for 1-1/2” Application	7129211

Greensand Plus™ is a trademark of Inversand Company.