

SHIPPING ASSEMBLIES

NORTH STAR WATER CONDITIONING PROFESSIONAL ADVANTAGE COMMERCIAL SERIES WATER SOFTENERS (2" VALVE)

**NOTE: ALL MODELS SHIPPED UNASSEMBLED.
SHIPPING WEIGHTS ARE APPROXIMATE.**

102S = #510201S 440#
132S = #513201S 500#

102D = #510201D 850#
132D = #513201D 960#

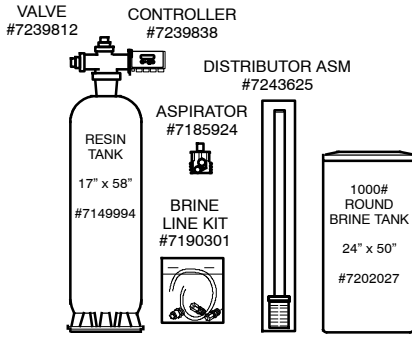

LITERATURE KIT #7240017



GRAVEL (2)* RESIN*
#7124423 - 1 102 - (3)
50 lbs. 132 - (4)
#7127073 - 1 1 cu.ft.
50 lbs. 1 cu.ft.

*Duplex models use double amounts
*Triplex models use triple amounts
*Quadplex models use quadruple amounts

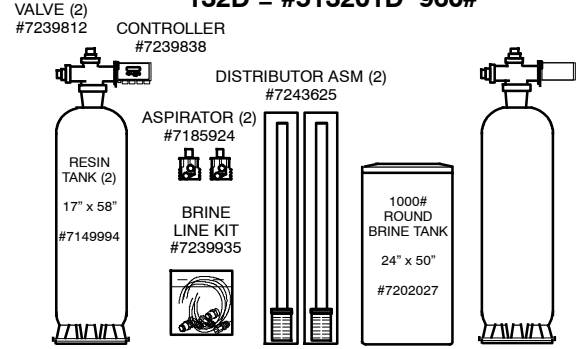

102T = #510201T 1290#
132T = #513201T 1450#

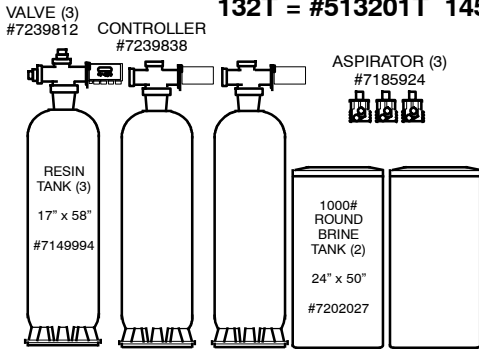

BRINE LINE KIT (2) #7239935



DISTRIBUTOR ASM (4) #7243625

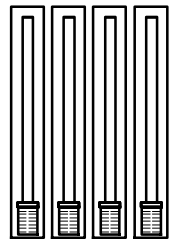

102Q = #510201Q 1700#
132Q = #513201Q 1870#

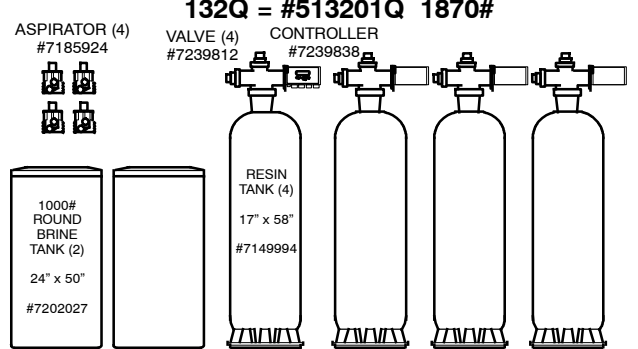

162S = #516201S 600#

162D = #516201D 1090#

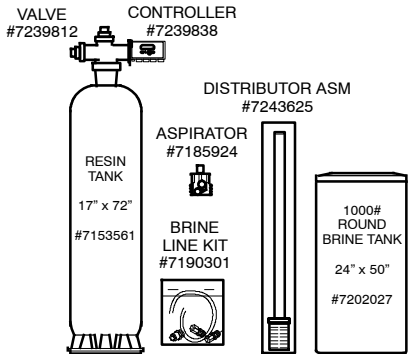

LITERATURE KIT #7240017



GRAVEL (2)* RESIN (5)*
#7124423 - 1 #0502272
50 lbs. 1 cu.ft.
#7127073 - 1 1 cu.ft.
50 lbs. 1 cu.ft.

*Duplex models use double amounts
*Triplex models use triple amounts
*Quadplex models use quadruple amounts

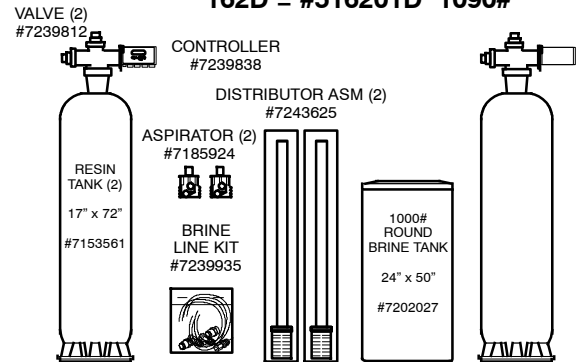

162T = #516201T 1640#

162Q = #516201Q 2130#

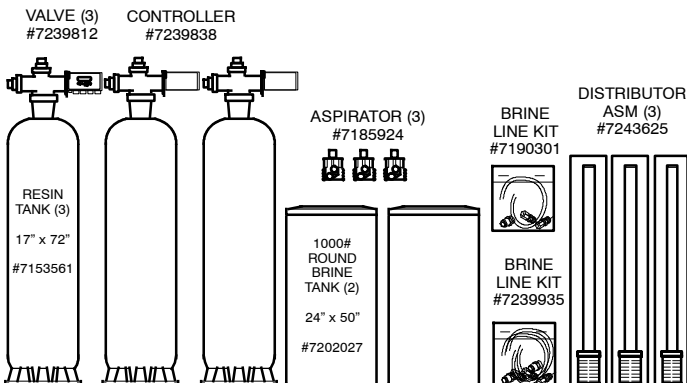

BRINE LINE KIT (2) #7239935



DISTRIBUTOR ASM (4) #7243625

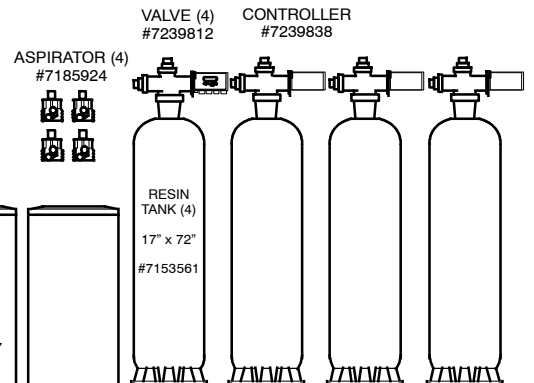
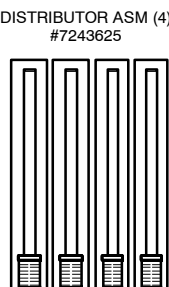

NORTH STAR WATER CONDITIONING PROFESSIONAL ADVANTAGE COMMERCIAL SERIES WATER SOFTENERS (2" VALVE)

192S = #519201S 820#
252S = #525201S 920#
322S = #532201S 1030#

**NOTE: ALL MODELS SHIPPED UNASSEMBLED.
SHIPPING WEIGHTS ARE APPROXIMATE.**

192D = #519201D 1490#
252D = #525201D 1710#
322D = #532201D 1920#

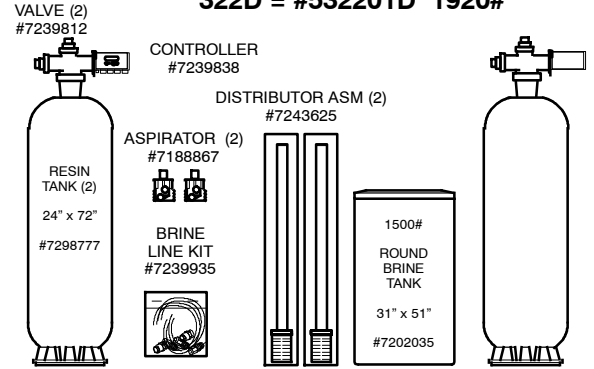
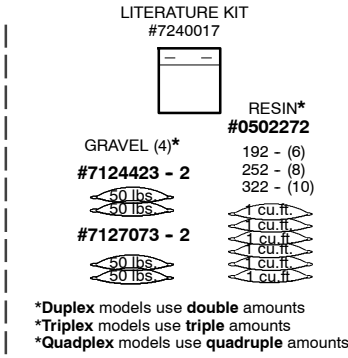
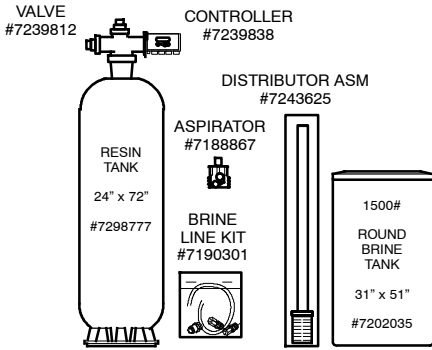

192T = #519201T 2260#
252T = #525201T 2590#
322T = #532201T 2910#

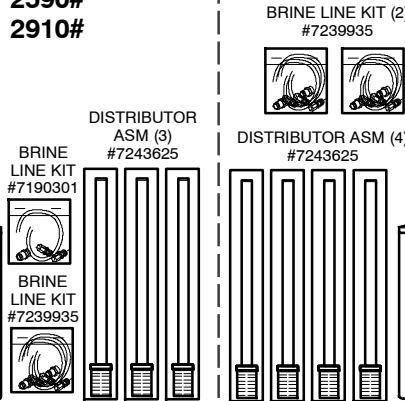
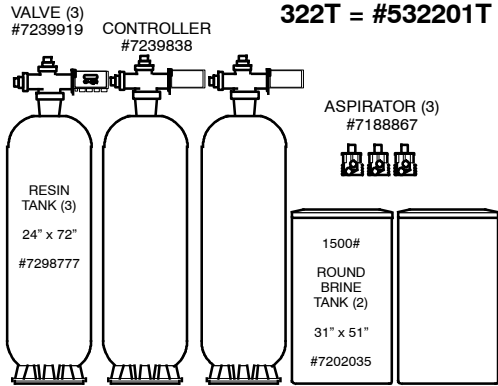

192Q = #519201Q 2940#
252Q = #525201Q 3410#
322Q = #532201Q 3840#

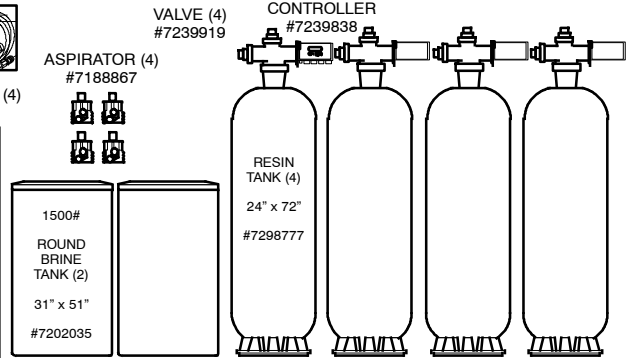

NORTH STAR WATER CONDITIONING PROFESSIONAL ADVANTAGE COMMERCIAL SERIES WATER FILTERS (2" VALVE)

NOTE: ALL MODELS SHIPPED UNASSEMBLED.
SHIPPING WEIGHTS ARE APPROXIMATE.

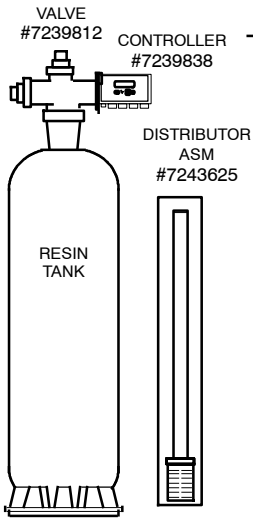

MODEL	SHIPPING WEIGHT	RESIN TANK	FILTER KIT	MINERAL BED
172CS = #17201CS	420#	17" x 58" #7149994	#7289126	①
242CS = #24201CS	770#	24" x 72" #7298777	#7289126	②
172MS = #17201MS	560#	17" x 58" #7149994	#7289126	③
242MS = #24201MS	1060#	24" x 72" #7298777	#7289126	④
172GS = #17201GS	660#	17" x 58" #7149994	#7289126	⑤
242GS = #24201GS	1160#	24" x 72" #7298777	#7289126	⑥

see table below

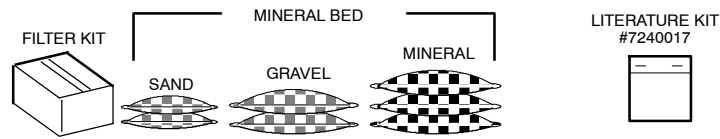

MINERAL BED (see above)	GRAVEL 7124423		FILTER SAND 0993080		ACTIVATED CARBON 3424509	MANGANESE GREENSAND 7330642	ANTHRACITE 0993070		GARNET 0993090	
	lbs.	bags	lbs.	bags	1 cu. ft. bags	1/2 cu. ft. bags	lbs.	bags	lbs.	bags
①	100	2	-	-	4	-	-	-	-	-
②	150	3	-	-	10	-	-	-	-	-
③	100	2	100	2	-	-	156	3	50	1
④	150	3	250	5	-	-	312	6	150	3
⑤	100	2	-	-	-	6	78*	2*	50	1
⑥	150	3	-	-	-	12	156	3	150	3

* 1-1/2 of the 2 bags included are used

BEDDING SEQUENCE OF GRAVEL AND MINERALS

NOTE: Be sure distributor assembly is centered in tank before filling.

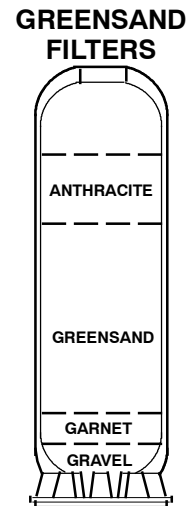
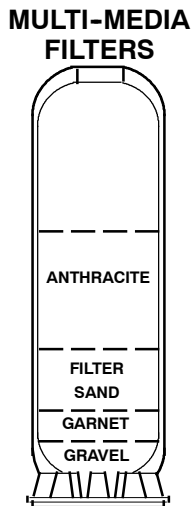
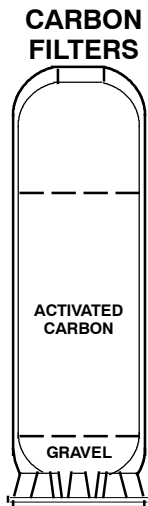

NORTH STAR WATER CONDITIONING PROFESSIONAL ADVANTAGE COMMERCIAL SERIES WATER FILTERS (2" VALVE)

NOTE: ALL MODELS SHIPPED UNASSEMBLED.
SHIPPING WEIGHTS ARE APPROXIMATE.

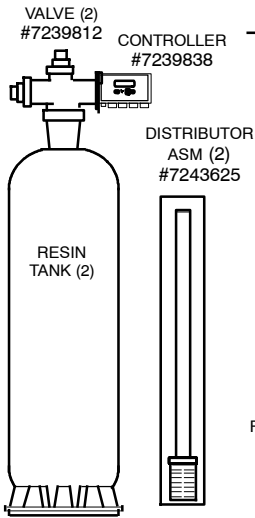

MODEL	SHIPPING WEIGHT	RESIN TANK	FILTER KIT	MINERAL BED
172CD = #17201CD	830#	17" x 58" #7149994	#7289126	①
242CD = #24201CD	1520#	24" x 72" #7298777	#7289126	②
172MD = #17201MD	1110#	17" x 58" #7149994	#7289126	③
242MD = #24201MD	2110#	24" x 72" #7298777	#7289126	④
172GD = #17201GD	1260#	17" x 58" #7149994	#7289126	⑤
242GD = #24201GD	2320#	24" x 72" #7298777	#7289126	⑥

see table below

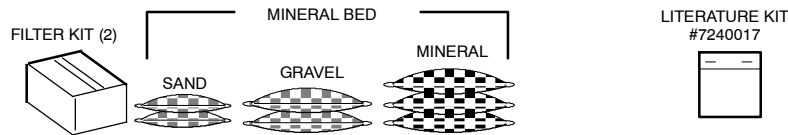

MINERAL BED (see above)	GRAVEL 7124423		FILTER SAND 0993080		ACTIVATED CARBON 3424509	MANGANESE GREENSAND 7330642	ANTHRACITE 0993070		GARNET 0993090	
	lbs.	bags	lbs.	bags	1 cu. ft. bags	1/2 cu. ft. bags	lbs.	bags	lbs.	bags
①	200	4	-	-	8	-	-	-	-	-
②	300	6	-	-	20	-	-	-	-	-
③	200	4	200	4	-	-	312	6	100	2
④	300	6	500	10	-	-	624	12	300	6
⑤	200	4	-	-	-	12	156	3	100	2
⑥	300	6	-	-	-	24	312	6	300	6

BEDDING SEQUENCE OF GRAVEL AND MINERALS

NOTE: Be sure distributor assembly is centered in tank before filling.

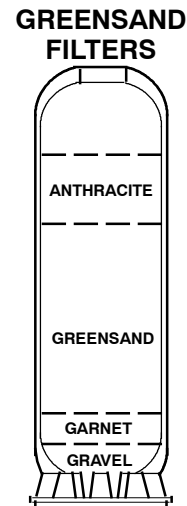
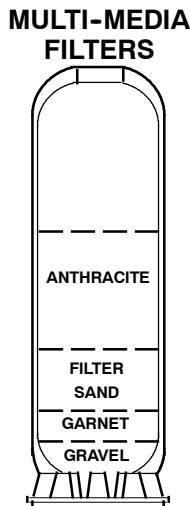
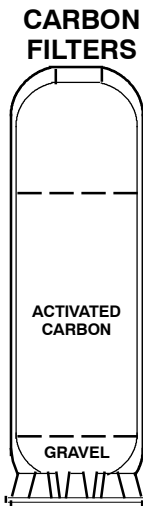

NORTH STAR WATER CONDITIONING PROFESSIONAL ADVANTAGE COMMERCIAL SERIES WATER FILTERS (2" VALVE)

NOTE: ALL MODELS SHIPPED UNASSEMBLED.
SHIPPING WEIGHTS ARE APPROXIMATE.

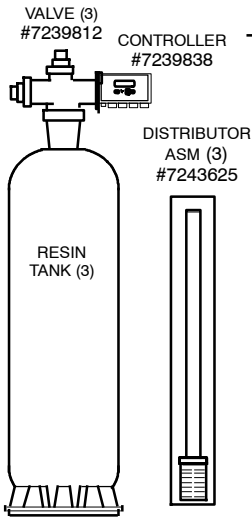

MODEL	SHIPPING WEIGHT	RESIN TANK	FILTER KIT	MINERAL BED
172CT = #17201CT	1250#	17" x 58" #7149994	#7289126	①
242CT = #24201CT	2320#	24" x 72" #7298777	#7289126	②
172MT = #17201MT	1660#	17" x 58" #7149994	#7289126	③
242MT = #24201MT	3200#	24" x 72" #7298777	#7289126	④
172GT = #17201GT	1920#	17" x 58" #7149994	#7289126	⑤
242GT = #24201GT	3480#	24" x 72" #7298777	#7289126	⑥

see table below

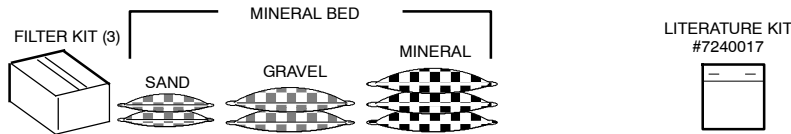

MINERAL BED (see above)	GRAVEL 7124423		FILTER SAND 0993080		ACTIVATED CARBON 3424509	MANGANESE GREENSAND 7330642	ANTHRACITE 0993070		GARNET 0993090	
	lbs.	bags	lbs.	bags	1 cu. ft. bags	1/2 cu. ft. bags	lbs.	bags	lbs.	bags
①	300	6	-	-	12	-	-	-	-	-
②	450	9	-	-	30	-	-	-	-	-
③	300	6	300	6	-	-	468	9	150	3
④	450	9	750	15	-	-	936	18	450	9
⑤	300	6	-	-	-	18	234*	5*	150	3
⑥	450	9	-	-	-	36	468	9	450	9

* 4-1/2 of the 5 bags included are used

BEDDING SEQUENCE OF GRAVEL AND MINERALS

NOTE: Be sure distributor assembly is centered in tank before filling.

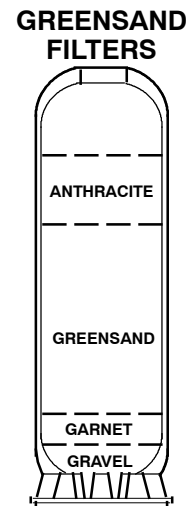
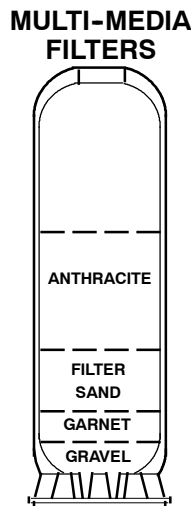
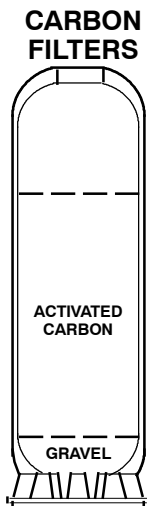

NORTH STAR WATER CONDITIONING PROFESSIONAL ADVANTAGE COMMERCIAL SERIES WATER FILTERS (2" VALVE)

NOTE: ALL MODELS SHIPPED UNASSEMBLED.
SHIPPING WEIGHTS ARE APPROXIMATE.

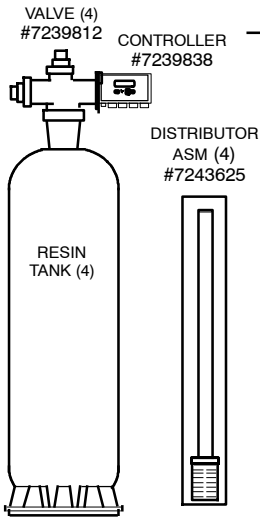

MODEL	SHIPPING WEIGHT	RESIN TANK	FILTER KIT	MINERAL BED
172CQ = #17201CQ	2080#	17" x 58" #7149994	#7289126	①
242CQ = #24201CQ	3050#	24" x 72" #7298777	#7289126	②
172MQ = #17201MQ	2210#	17" x 58" #7149994	#7289126	③
242MQ = #24201MQ	4050#	24" x 72" #7298777	#7289126	④
172GQ = #17201GQ	2520#	17" x 58" #7149994	#7289126	⑤
242GQ = #24201GQ	4670#	24" x 72" #7298777	#7289126	⑥

see
table
below

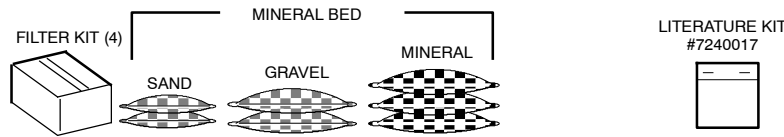

MINERAL BED (see above)	GRAVEL 7124423		FILTER SAND 0993080		ACTIVATED CARBON 3424509	MANGANESE GREENSAND 7330642	ANTHRACITE 0993070		GARNET 0993090	
	lbs.	bags	lbs.	bags	1 cu. ft. bags	1/2 cu. ft. bags	lbs.	bags	lbs.	bags
①	400	8	-	-	16	-	-	-	-	-
②	600	12	-	-	40	-	-	-	-	-
③	400	8	400	8	-	-	624	12	200	4
④	600	12	1000	20	-	-	1248	24	600	12
⑤	400	8	-	-	-	24	312	6	200	4
⑥	600	12	-	-	-	48	624	12	600	12

BEDDING SEQUENCE OF GRAVEL AND MINERALS

NOTE: Be sure distributor assembly is centered in tank before filling.

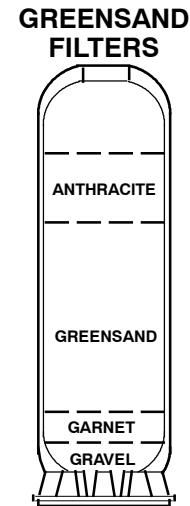
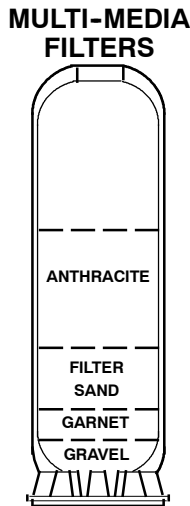
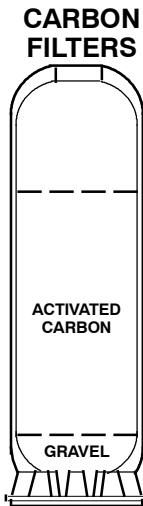

NORTH STAR WATER CONDITIONING PROFESSIONAL ADVANTAGE COMMERCIAL SERIES WATER CONDITIONERS (1" VALVE)

1. All models have 1" inlet and outlet connection. For 1-1/2" connection, order Adaptor Kit, #7129211

071S = #507101S 200#

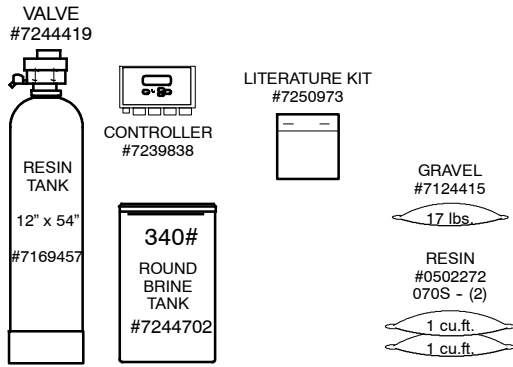

071D = #507101D 390#

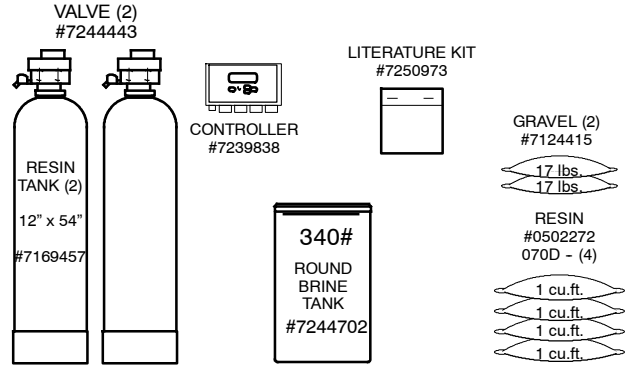

071T = #507101T 600#

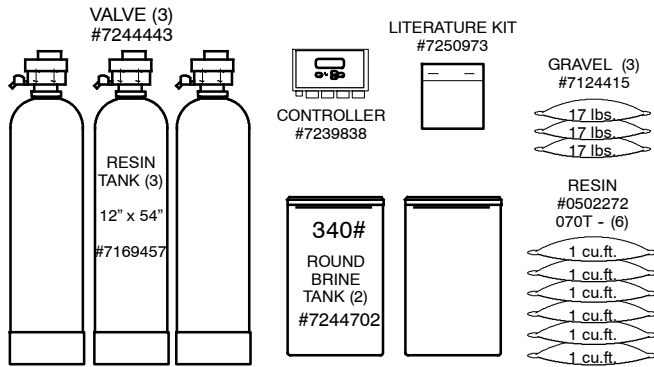

071Q = #507101Q 780#

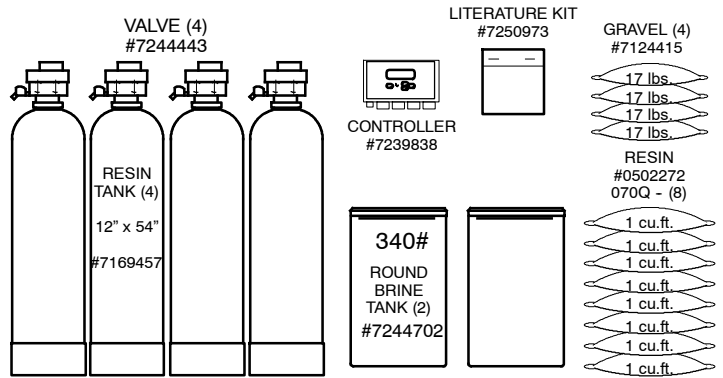

101S = #510101S 300# 131S = #513101S 360#

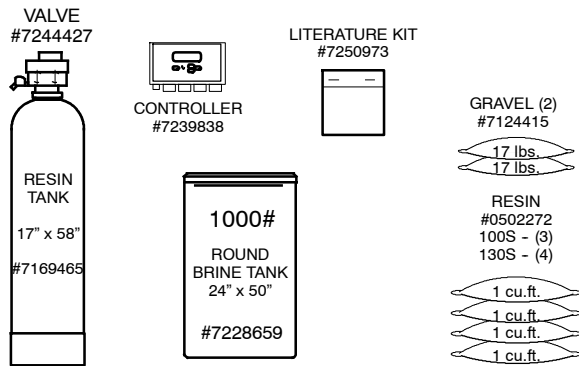

101D = #510101D 590# 131D = #513101D 690#

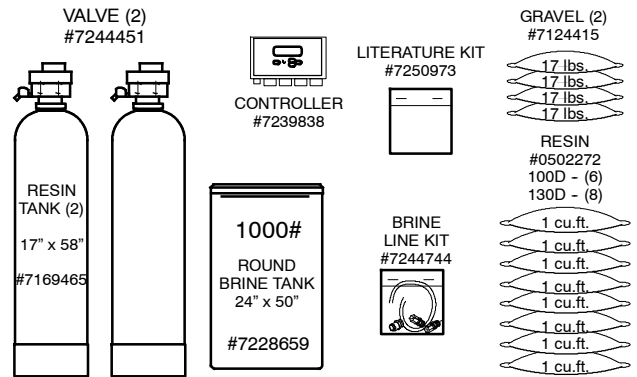

101T = #510101T 900# 131T = #513101T 1050#

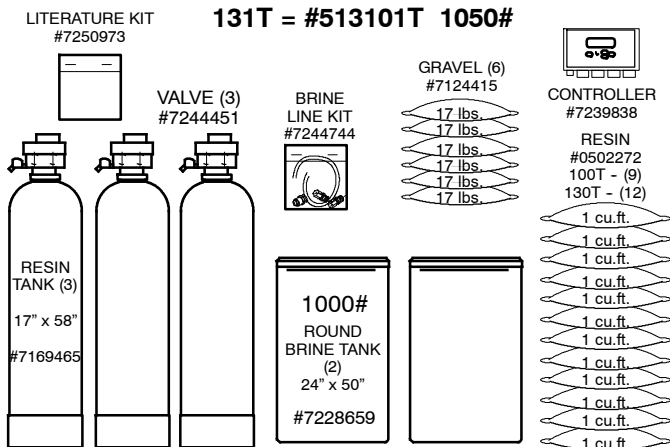

101Q = #510101Q 1180# 131Q = #513101Q 1390#

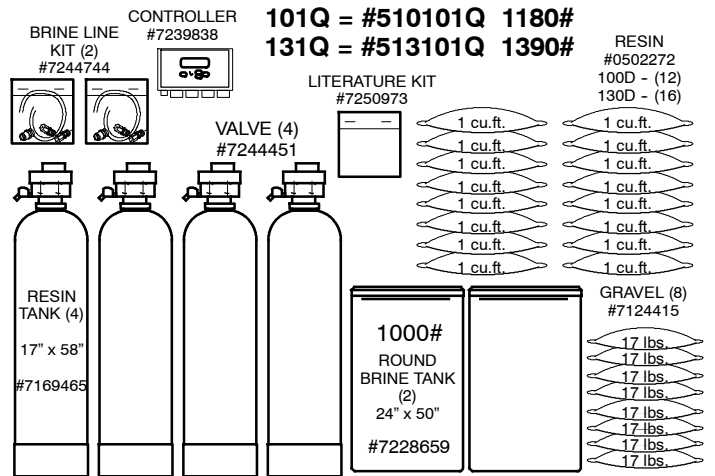

NORTH STAR WATER CONDITIONING PROFESSIONAL ADVANTAGE COMMERCIAL SERIES WATER CONDITIONERS (1" VALVE)

1. All models have 1" inlet and outlet connection. For 1-1/2" connection, order Adaptor Kit, #7129211

191S = #519101S 620#
251S = #525101S 720#
321S = #532101S 820#

191D = #519101D 1290#
251D = #525101D 1500#
321D = #532101D 1700#

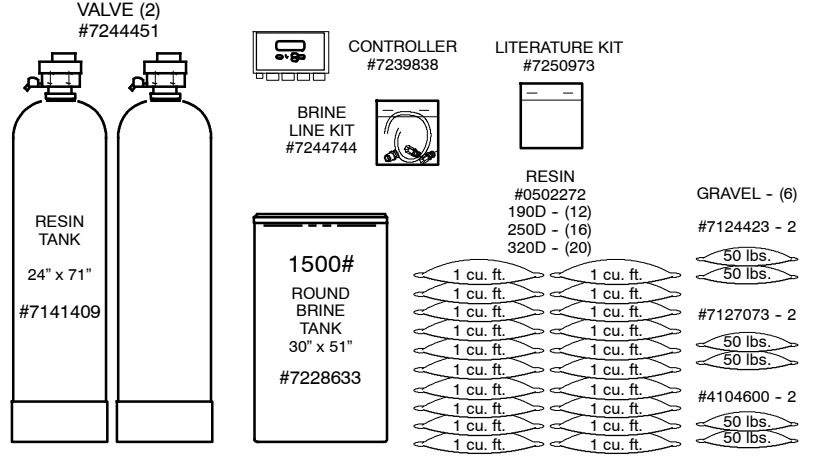
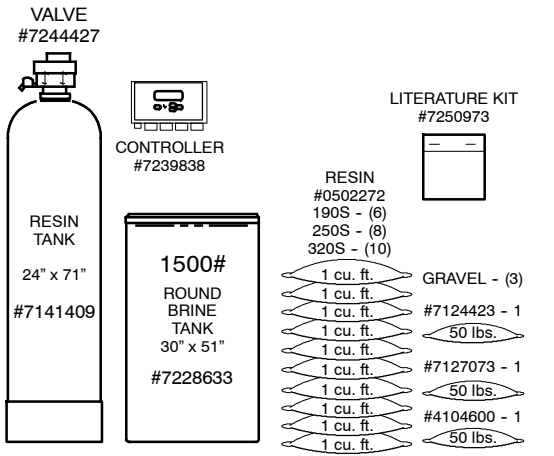

191T = #519101T 1910#
251T = #525101T 2220#
321T = #532101T 2530#

191Q = #519101Q 2580#
251Q = #525101Q 2990#
321Q = #532101Q 3410#

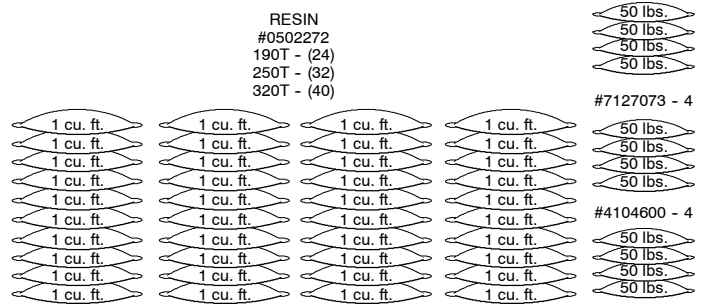
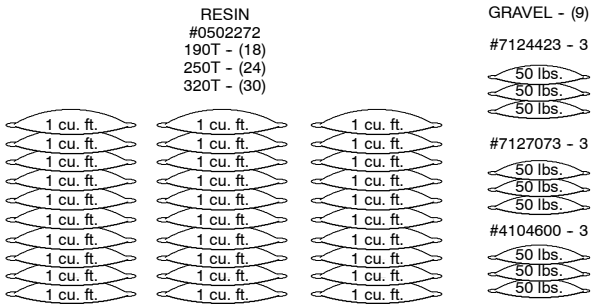
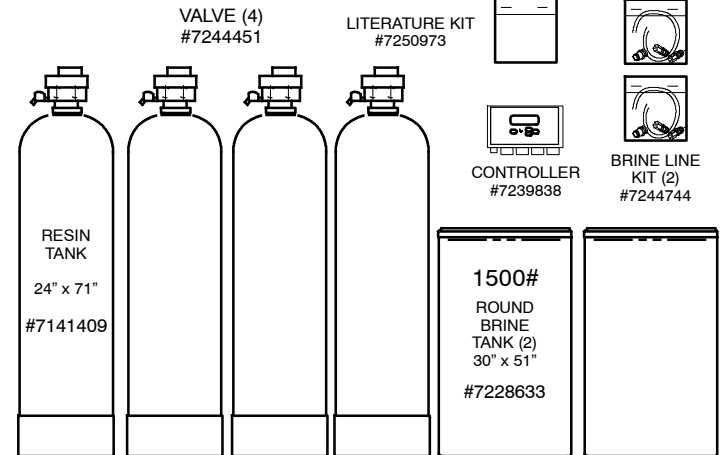
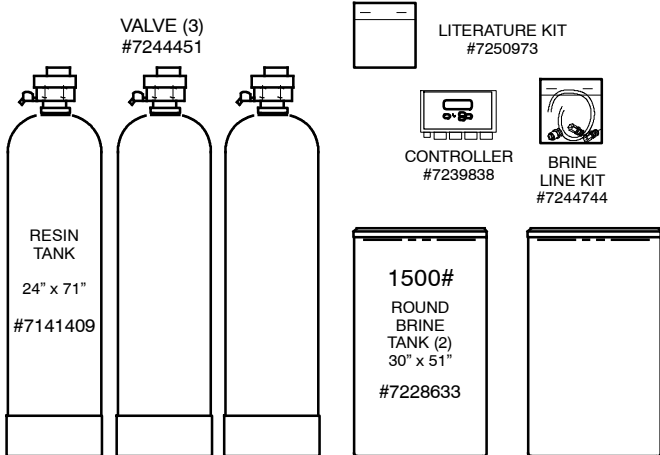

NORTH STAR WATER CONDITIONING PROFESSIONAL ADVANTAGE COMMERCIAL SERIES WATER FILTERS (1" VALVE)

All models have 1" inlet and outlet connection. For 1-1/2" connection, order Adaptor Kit, #7129211.



MODEL

121XS = #12101XS 100#
121CS = #12101CS 180#
121MS = #12101MS 340#
121GS = #12101GS 440#

MODEL	GRAVEL 7124415		FILTER SAND 0993080		ACTIVATED CARBON 3424509	MANGANESE GREENSAND 7330642	ANTHRACITE 0993070		GARNET 0993090	
	lbs.	bags	lbs.	bags	1 cu. ft. bags	1/2 cu. ft. bags	lbs.	bags	lbs.	bags
121XS	34	2	-	-	-	-	-	-	-	-
121CS	17	1	-	-	2	-	-	-	-	-
121MS	34	2	50	1	-	-	52	1	50	1*
121GS	17	1	-	-	-	3	52	1*	50	1*

* 1/2 of the 1 bag included is used

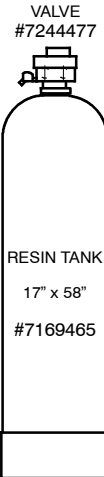

MODEL

171XS = #17101XS 150#
171CS = #17101CS 350#

MODEL	GRAVEL 7124423		ACTIVATED CARBON 3424509
	lbs	bags	1 cu. ft. bags
171XS	100	2	-
171CS	100	2	4

NORTH STAR WATER CONDITIONING PROFESSIONAL ADVANTAGE COMMERCIAL SERIES WATER FILTERS (1" VALVE)

All models have 1" inlet and outlet connection. For 1-1/2" connection, order Adaptor Kit, #7129211.

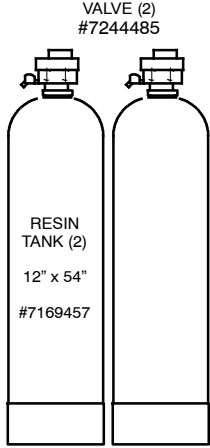

MODEL

121XD = #12101XD 190#
121CD = #12101CD 370#
121MD = #12101MD 620#
121GD = #12101GD 830#

MODEL	GRAVEL 7124415		FILTER SAND 0993080		ACTIVATED CARBON 3424509	MANGANESE GREENSAND 7330642	ANTHRACITE 0993070		GARNET 0993090	
	lbs.	bags	lbs.	bags	1 cu. ft. bags	1/2 cu. ft. bags	lbs.	bags	lbs.	bags
121XD	68	4	-	-	-	-	-	-	-	-
121CD	34	2	-	-	4	-	-	-	-	-
121MD	68	4	100	2	-	-	104	2	50	1
121GD	34	2	-	-	-	6	52	1	50	1

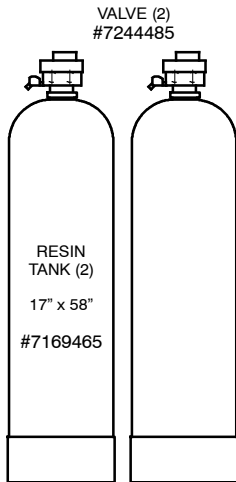

MODEL

171XD = #17101XD 300#
171CD = #17101CD 700#

MODEL	GRAVEL 7124423		ACTIVATED CARBON 3424509
	lbs	bags	1 cu. ft. bags
171XD	100	2	-
171CD	200	4	8

NORTH STAR WATER CONDITIONING PROFESSIONAL ADVANTAGE COMMERCIAL SERIES WATER FILTERS (1" VALVE)

All models have 1" inlet and outlet connection. For 1-1/2" connection, order Adaptor Kit, #7129211.

VALVE (3)
#7244485



LITERATURE KIT
#7255800



MODEL

121XT = #12101XT 300#
121CT = #12101CT 540#
121MT = #12101MT 860#
121GT = #12101GT 1170#

MODEL	GRAVEL 7124415		FILTER SAND 0993080		ACTIVATED CARBON 3424509	MANGANESE GREENSAND 7330642	ANTHRACITE 0993070		GARNET 0993090	
	lbs.	bags	lbs.	bags	1 cu. ft. bags	1/2 cu. ft. bags	lbs.	bags	lbs.	bags
121XT	102	6	-	-	-	-	-	-	-	-
121CT	51	3	-	-	6	-	-	-	-	-
121MT	102	6	150	3	-	-	156	3	100	2
121GT	51	3	-	-	-	9	104	2*	100	2

* 1-1/2 of the 2 bags included are used

VALVE (3)
#7244485



LITERATURE KIT
#7255800



MODEL

171XT = #17101XT 580#
171CT = #17101CT 1060#

MODEL	GRAVEL 7124423		ACTIVATED CARBON 3424509
	lbs	bags	1 cu. ft. bags
171XT	300	6	-
171CT	300	6	12

NORTH STAR WATER CONDITIONING PROFESSIONAL ADVANTAGE COMMERCIAL SERIES WATER FILTERS (1" VALVE)

All models have 1" inlet and outlet connection. For 1-1/2" connection, order Adaptor Kit, #7129211.

VALVE (4)
#7244485

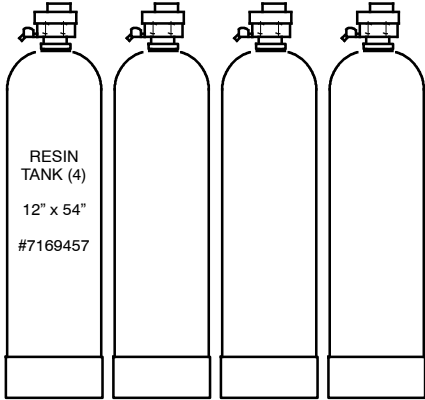

LITERATURE KIT
#7255800



MODEL

121XQ = #12101XQ 400#
121CQ = #12101CQ 740#
121MQ = #12101MQ 1150#
121GQ = #12101GQ 1600#

MODEL	GRAVEL 7124415		FILTER SAND 0993080		ACTIVATED CARBON 3424509	MANGANESE GREENSAND 7330642	ANTHRACITE 0993070		GARNET 0993090	
	lbs.	bags	lbs.	bags	1 cu. ft. bags	1/2 cu. ft. bags	lbs.	bags	lbs.	bags
121XQ	136	8	-	-	-	-	-	-	-	-
121CQ	68	4	-	-	8	-	-	-	-	-
121MQ	136	8	200	4	-	-	208	4	100	2
121GQ	68	4	-	-	-	12	104	2	100	2

VALVE (4)
#7244485

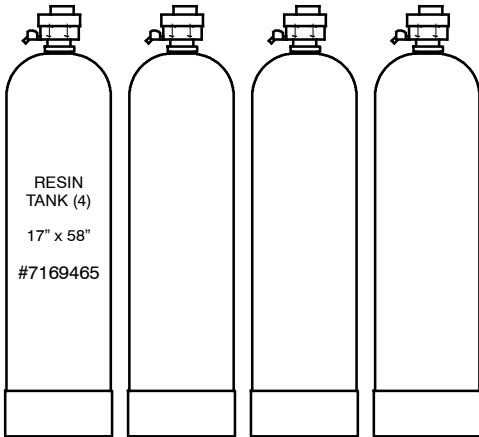

LITERATURE KIT
#7255800



MODEL

171XQ = #17101XQ 820#
171CQ = #17101CQ 1190#

MODEL	GRAVEL 7124423		ACTIVATED CARBON 3424509
	lbs	bags	1 cu. ft. bags
171XS	400	8	-
171CS	400	8	16

BEDDING SEQUENCE OF GRAVEL AND MINERALS

NOTE: Be sure distributor assembly is centered in tank before filling.

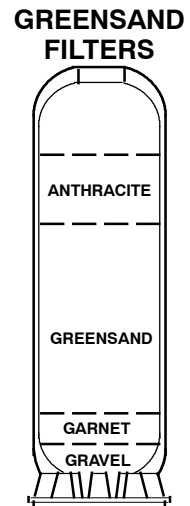
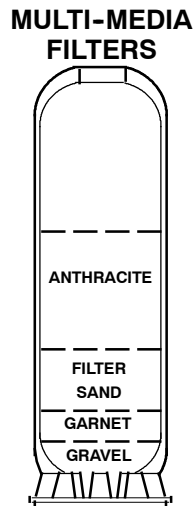
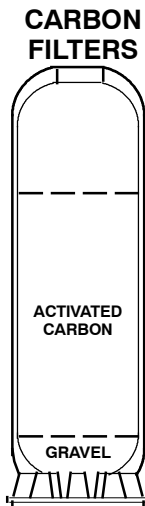

Media

	Part Number	Weight (lbs)
Resin	0502272	53
Gravel, Quartz	7124415	17
Gravel, Quartz	7124423	50
Gravel, Medium	7127073	50
Anthracite	0993070	52
Garnet	0993090	50
Sand, Filter	0993080	50
Activated Carbon	3424509	42
Manganese Greensand	7330642	44

Accessories

Hard Water Bypass Prevention Kits - 2" Valve

	Part Number
2" Valve Piston plug	7229443
Grip Ring for above	7192769
2" External shut-off valve	7280350
Switch kit for external shut-off valve	7205172

Adaptors for 1-1/2" Application

Part Number
7129211 (contains 2 each)